

**WHAT'S
NEW ▼
2023**

Rockworth[®]



**Modern Furniture
+
Smart Technology
+
Architectural Systems
=
Rockworth®**



THAT ENHANCE BUSINESSES
BY SUPPORTING PEOPLE
TO ACCESS THEIR
BEST WORK.

The Age Of
FLEXIBILITY

**WORKSPACE
SUPPORTING PEOPLE**

Over the past two decades, new technologies are driving the global change forward and continue to transform the way organizations work.

Nowadays, people can work more flexibly than ever before, new work styles have emerged that giving people choice over where, when and how they get their work done but despite all of this change.

...the role of making performing workspace for people remains essential for business success.

AFTER

50

YEARS



IN BUSINESS
OUR PROVEN TRACK RECORD IS
SOMETHING WE ARE INCREDIBLY PROUD OF.

INCREDIBLY PROUD OF...

900
Members of Staff
Internationally

50
Years of
Experience

27
Countries
Contracted
Partner



17
Global Locations
Showroom

1,972
Trust Heritage

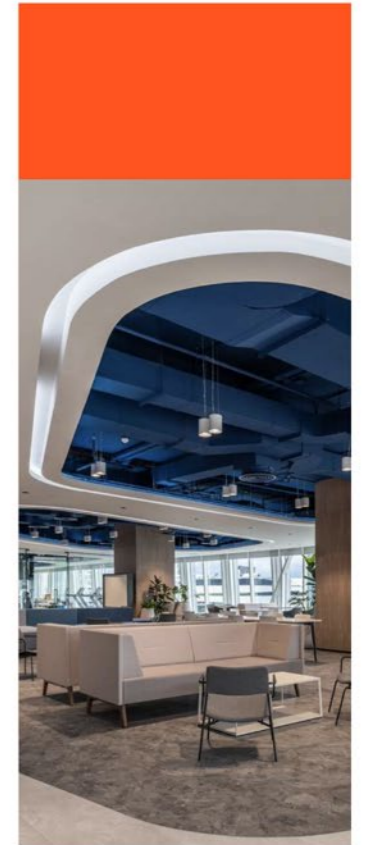

90,000m²
Manufacturing
Facilities

'SpaceWorks'

Office is the place where idea, creativity, innovation and success become real.

From here, we started the concept of 'SpaceWorks', the science of integrated solutions to create a modern office. It is a place where people work, meet and connect.



The way we work has changed. From the rise of mobile knowledge workers to generational changes and technological advances, many forces are continuously impacting how and where we work.

Nowadays, people can work more flexibly than ever before. To stay relevant in this fast-paced world, our work environments need to change.

The concept of 'SpaceWorks' will be the solution to create a Modern working environment by merging the modern spaces with the digital solutions, companies can give their employee the flexibility to work in the way that they need. Our variety of furnitures along with technology solutions designed to promote communication, movement and employee health.

Our solutions also support your people working on a diverse range of activities, from deep thinking to knowledge sharing and collaboration. As a result, the organization, can enhance the experience of the employees, leading to better them collaboration, more innovation, and more knowledge-sharing while decreasing office space cost which in turn boosts business performance.

WELCOME TO A

MODERN OFFICE

▼ we're entering the era of the modern smart office.

BUT WHAT DOES IT REALLY MEAN?

WHAT MAKES AN OFFICE 'SMART'?

Today's employees want to work in a way that suits them. Sitting or standing, a bustling central workspace or a smaller quiet space, indoor and outdoor areas, people want to move seamlessly between the buildings and spaces. Forward-thinking companies are creating flexible and modern spaces to increase collaboration and productivity. But they can do more. The office of the future is not just a beautiful building. It is a modern smart office.

It's about an integrated environment that combines thoughtful modern workspace and smart technology; forming a culture that enhanced productivity and employee experience to

▼ **WORK smarter, better, and faster.**

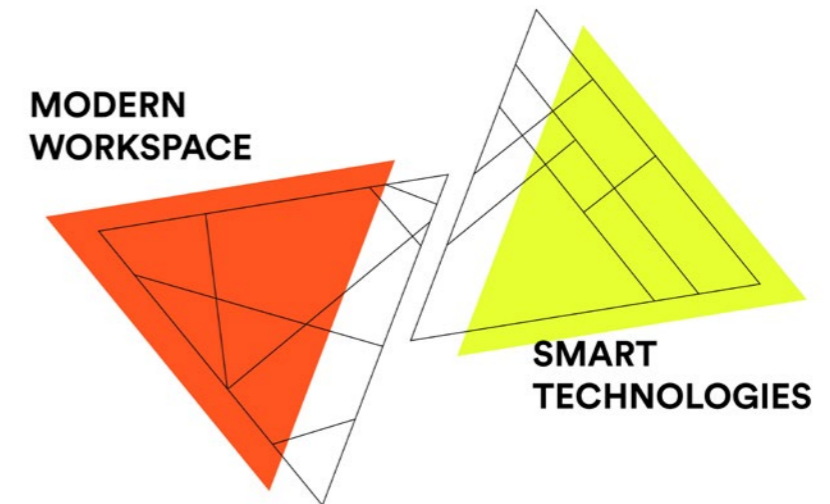

Modern workspaces are designed to provide a variety of work setting and areas of an office that allow employees to choose based on a diverse range of tasks throughout the day, from deep thinking to knowledge sharing, collaboration and everything in between.

A smart Office refers to the use of connected technologies to support modern workspace in order to engage employees with their work environment.

THE IDEA

OF A NEW OFFICE

A GUIDE TO CREATE INSPIRING WORKSPACE

FURNITURE

CREATE MODERN WORKSPACE THAT SUPPORT COLLABORATION, FOCUS, INNOVATION, LEARNING AND SOCIALIZING.

ARCHITECTURAL & ACOUSTIC SYSTEMS

CREATE FLEXIBLE WORKSPACE THAT ADAPT AND SUPPORT PRIVACY.

SMART TECHNOLOGY

CREATE SMART WORKSPACE THAT SEAMLESS INTEGRATION OF EMPLOYEE, WORKSPACE AND TECHNOLOGY TO ENSURE SPACE OPERATE EFFICIENTLY

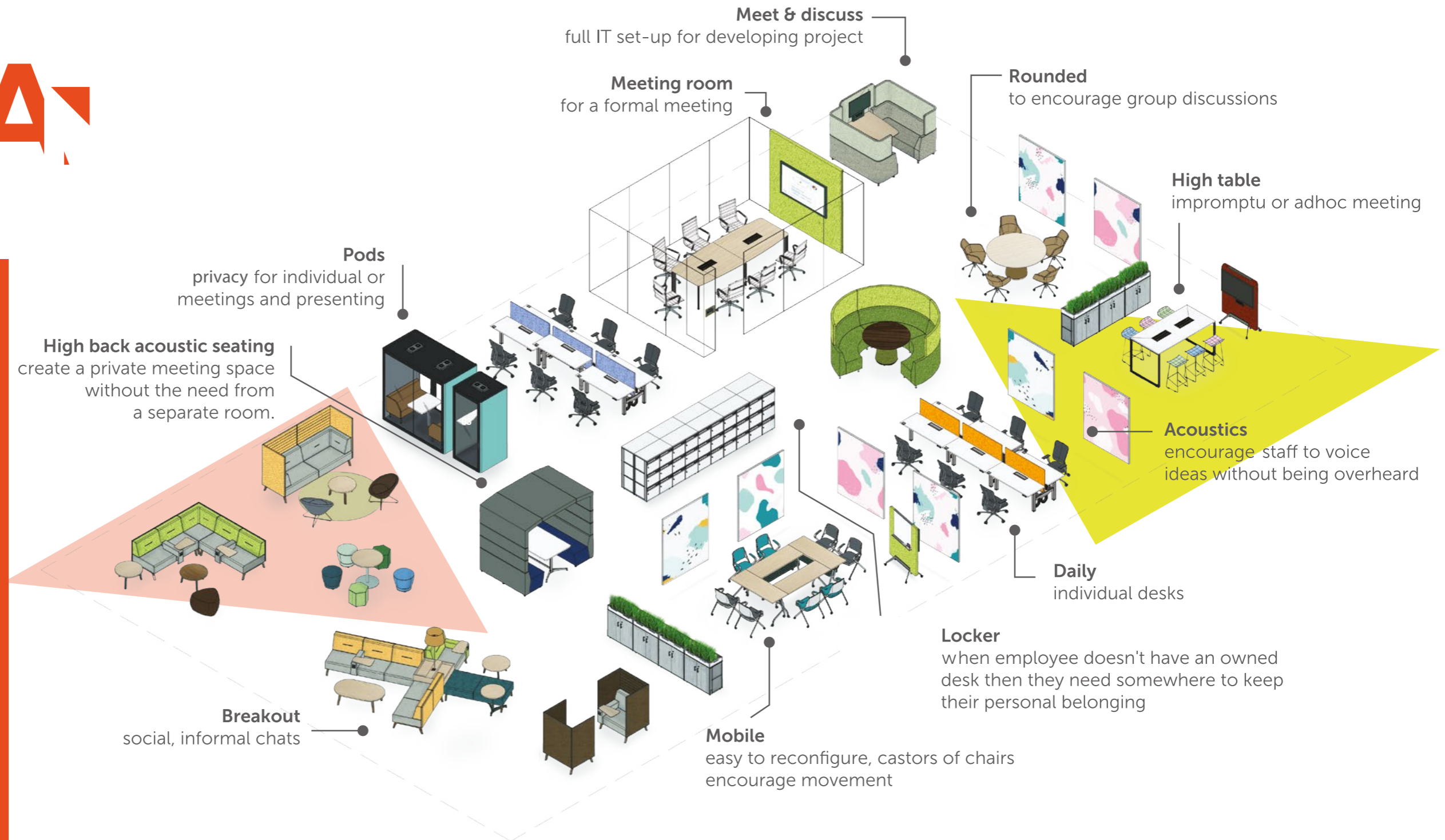

URBAN

Desking & Systems

SYNC

Table & Training Systems

Our expert teams can help you reimagine your offices with a focus on the needs of your employees and create better work experiences for your entire organization.



WHAT'S NEW 2023



Urban

Height- adjustable table.

DESIGN FOR WELL-BEING

URBAN, ergonomic, innovative and stylish height-adjustable desks make movement a natural part of your day as you transition from sitting to standing that enhance productivity, comfort, and well-being.





A FRESH AND DIFFERENTIATING LOOK

URBAN, ergonomic, innovative and stylish height-adjustable desks make movement a natural part of your day as you transition from sitting to standing that enhance productivity, comfort, and well-being.





FLEXIBILITY MEET STYLE

Everyone works differently. Through a variety of features and material options, URBAN adapts to fit the individual user, letting you choose how to work.

FRAME

URBAN is unique, differential and aesthetic thanks to round legs. Choose I-feet design for a minimal look and Y-feet design to define a unique modern style.

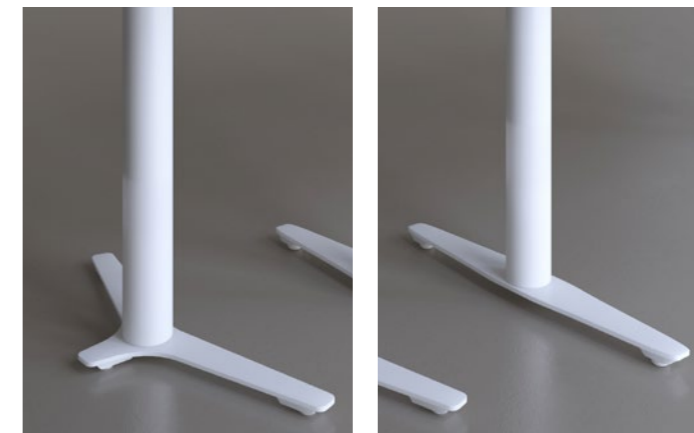



PERFECT DESK CONTROL PANEL

With our latest technology, we introduce an intuitive desk panel for office desks. These control panels enable the user to maneuver the desk high and position to different styles of work and purposes.

The desk can be adjusted from the lowest of 635 – 1270 mm. highest by the power of 2 silent motors. Result in Anti-Collision Technology that allows uninterrupted movement throughout the workday. The panel offers four different memory positions that have a reminder function



that appears via a strip light. Display panel is clear with the special access of Bluetooth, where you can connect to your personal mobile and will be able to adjust the height through tapping on your device. Lastly, with our Featuring ZERO™ system, consumption of the power is very low due to our standby mode.

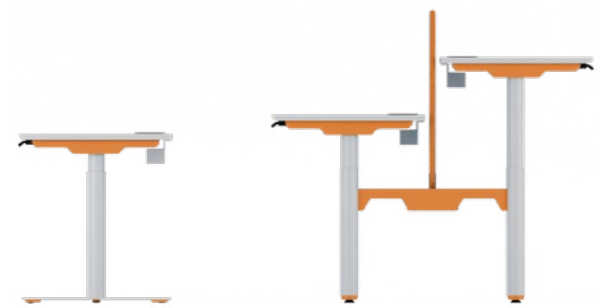

DESIGN CHOICES

The utilization of legs design, different types of worksurfaces, and a selection of colors, can infuse inspiration and energy into the workspace. These elements can be used to create a welcoming work environment in team spaces by harmonizing with the overall aesthetic of the area.



PRIVACY SCREENS



Privacy that move up and down with you. Urban screen provides a solution for the challenge of open-space with a range of colors and material finishes.

**Screen on top
(Fabric screen)**

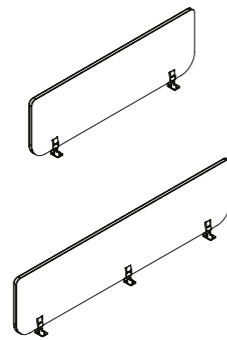

**Screen plus modesty
for single desk
(Fabric screen)**

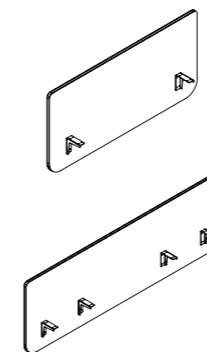

**Screen for double desk
(Fabric screen)**

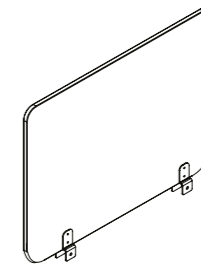



Sync

Solutions for agile working

Creating Space for productive and creative work with SYNC

There is a need for more flexibility when it comes to Agile working. For more productive and creative work entire offices must be flexible allow spontaneous meeting and assembled in no time.

Sync allows to redesign the space, simply put your own work desk together with colleagues' work desk when and where it makes sense to work / meet / connect effectively. All components can be individually combined and allow great freedom depending on work requirement.



for more productivity

The way we work has changed. Nowadays, people can work more flexibly than every before. As a result, tomorrow's employees will work in more agile way - creatively and constantly communicating. Agile working means that teams can get together spontaneously for a project or task. However, individual employees may also need mobile retreats where they can concentrate undisturbed and work creatively.

SYNC OFFERS TEAM THE POSSIBILITY

to adapt their own space to their needs. A new concept of SYNC that enables to redesign space quickly and efficiently from work desk to team desks. Its modular function and incorporation of casters allow you to create new areas easily hence, it can be also reconfigured depending on your needs.







TRAPEZOID TABLE

This compact, contemporary trapezoid desk designed for solo work or collaboration provides solid functionality and great flexibility. It can be arranged in countless ways for groups of all size.

CURVED TABLES

The versatile curved mobile table, is a fun shape that can be arranged in a variety of creative ways. Use a single curved table or join multiple together for a larger collaborative space.







Box

POD & BOOTHS

When you need to work with maximum focus and minimal distraction, just get into a BOX. It's a compact workspace with huge benefits. Each BOX is highly ergonomic and functional, packed with all the technological goodness you need to stay connected to, or away from, the outside world—anytime. Ideal for uninterrupted work, holding discussions, making important calls, and running teleconferences.



I-BOX

Up to one person

POD & BOOTHS

I-BOX is designed to fit one person. When you need to work with maximum focus and minimal distraction, just get into a I-BOX

FIXED AND FOCUSED

The I-BOX is a single person private space suitable for uninterrupted work and making important calls. This quiet and comfortable workspace can increase employee productivity, especially in an open-concept office.



I-BOX

W1010 D1010 H2170

WEIGHT: 325.2 kg (steel) / 308.1 kg (wooden)

FOCUS-BOX

Up to one person

POD & BOOTHS

FOCUS-BOX is designed to work in absolute focus and privacy, the FOCUS-BOX is perfect to seats one person comfortably.

CALM AND CONNECTED

When you need to work in absolute focus and privacy, the FOCUS-BOX is perfect. It seats one person comfortably, and is soundproofed for absolute quiet, making it also perfect for phone and video calls. With its glass walls all around to allow daylight into the booth, it creates a great and COSY working environment.



Focus-BOX

W1500 D1200 H2170

WEIGHT: 488.2 kg (steel) / 467 kg (wooden)



We-BOX

W2200 D1200 H2170

WEIGHT: 630.4 kg (steel) 609.2 kg (wooden)
with SOFA 706.4 kg (steel) 685.2 kg (wooden)



WE-BOX



Up to
four people

POD & BOOTHS

WE-BOX is designed to fit two to four people without sacrificing the compact size or usability of the WE-BOX.

COSY COLLABORATIONS

WE-BOX is perfect for holding meetings, brainstorming sessions, one-on-one conversations, as well as a place to rest and rejuvenate away from the disturbance of an open space. It's a comfortable and well-ventilated space with great acoustic properties; resulting in increased employees efficiency and productivity.



Chat-BOX

W2200 D1200 H2170

WEIGHT: 641.41 kg (steel) / 620.2 kg (wooden)



CHAT-BOX



Up to two people

POD & BOOTHS

CHAT-BOX is designed for functional working to seat up to two people comfortably. It is ideal for co-working tasks.

DISTRACTION-FREE DISCUSSION

The CHAT-BOX is a great functional working space designed to seat up to two people comfortably. It is ideal for co-working tasks like small discussions, interviews, brainstorming, phone calls, and video conferences; all this with minimal distractions. It is also easy to assemble and relocate to fit different office layouts.

MEET-BOX

 Up to four or six people

POD & BOOTHS

MEET-BOX is designed to fit four to six persons. Perfect for big discussions and meetings for groups of up to six people, the MEET-BOX is a designed for maximum capacity and efficiency.

MAXIMIZED FOR MEETINGS

Perfect for big discussions and meetings for groups of up to 10 people, The MEET-BOX is a large space designed for maximum capacity, connectivity, and efficiency. All the while keeping its outside surroundings quiet and undistracted. It's even spacious enough to be furnished with sofas, tables, chairs, white boards, screens and even plants for a comfortable working environment.



Meet-BOX

W2400 D2000 H2170

WEIGHT: 937.3 kg (steel) / 898.1 kg (wooden)



Meet6-BOX

W2400 D3000 H2170

WEIGHT: 1,279.5 kg (steel) / 1,220.7 kg (wooden)

EXECUTIVE CHAIRS

Volf

Executive Chairs



VOLF completes the beauty of the classic and luxurious comfort like first-class.

Precise leather finishes combined with aluminum elements.



Overall (mm.)

HIGHBACK (With Headrest)	W680 D680 H1200
HIGHBACK	W680 D680 H1200
MIDBACK	W680 D680 H1100

PIN UP
DESIGN AWARDS





Monte

Executive Chairs

MONTE demonstrates the unique maturity and modern elegance of Italian style. For an executive manager who pursues excellence and cares about the aesthetics of the workplace, this is "The Choice"

High-quality leather and fine details highlight the prestige and taste of the seating



Overall (mm.)

HIGHBACK	W660 D680 H1170-1230
MIDBACK	W660 D650 H1010-1070



Nex

Task Chairs

TASK CHAIRS

NEX is a light ergonomic office chair to use in normal sitting positions and sitting high with open angle between upper body and legs to provoke better blood circulation and right S-curve on back spine.



Overall (mm.)

MIDBACK

W530 D490-550 H840-1040

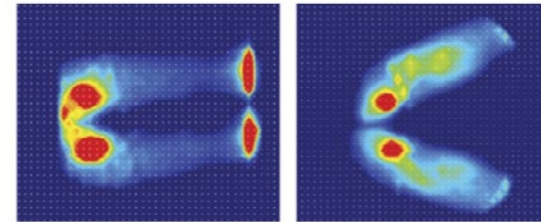

Traditional office chair pressure heat map

New Ergonomic Chair pressure heat map

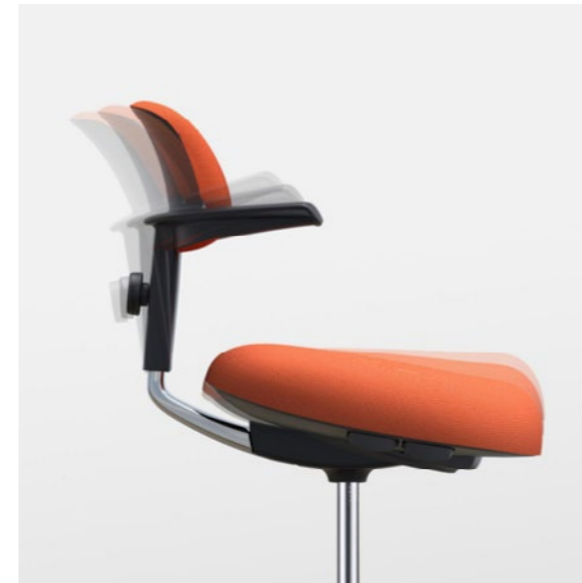

Balance and relaxation

NEX is a light ergonomic office chair to use in normal sitting positions and sitting high with open angle between upper body and legs to provoke better blood circulation and right S-curve on back spine.

All scientific research shows that open angle between legs and backrest creates more blood flow in the body and less pressure on the spine in the lower section, which is the two most dangerous consequences sitting for long hours.

Nox

Task Chairs

NOX chair is a perfect complement to the office space. It allows employees to get away from the busy office desks and interact with each other more efficient at the bar or around the round table. NOX is compact, lively and expressive, which not only promotes creative collaboration, but also makes the space full of vitality.



SEATING · Task Chairs

SEATING · Task Chairs

Overall (mm.)

MIDBACK

W530 D490-550 H840-1040



Non-slip base stable support



15mm backrest height adjustment

Lotto

Task Chairs

Bending wood veneer structure, PU Molded foam, and upholstered seat, upholstered bottom.

Mesh backrest with height adjustable lumbar support.



Overall (mm.)

Seat (mm.)

HIGHBACK	W685 D605-685 H1115-1210	SW500 SD500 SH420-515
MIDBACK	W685 D580-660 H950-1045	SW500 SD500 SH420-515

Yoo

Task Chairs

YOO makes you feel comfortable, and no back pain. The backrest is designed to support lock adjustment and able to be rotated in all directions for weight loss.



Overall (mm.)

HIGHBACK	W670 D480 H1180-1280
MIDBACK	W670 D480 H950-1050



Arial

Task Chairs

Outstanding with attractive adjustable armrest and lumbar support feature to promote any ergonomic postural position.



Overall (mm.)

HIGHBACK	700D 700W 1230H
MIDBACK	700D 700W 1070H
VISITOR	670D 610W 1000H



LOUNGE CHAIRS

Lounge Seating

Lounge chairs can play both fashionable and functional roles in any seating area. Perfect for waiting or breakout areas. With their large size, these comfortable lounge chairs can visually balance a large sofa or sectional. Their generous proportions also provide comfortable seating.



BARON LOUNGE CHAIR
W480 D640 H740
SH430



SIDE CHAIRS

Seating

Usability of our product is an important concept. We designed the product to support the variety of activity. This makes the design of each product able to support multiple functions from concentration to collaboration and able to support a variety areas such as working space, conference rooms, brainstorming areas and lounges.



BARON ARMCHAIR

W570 D545 H800

SH480





CLINE
W620 D600 H800
SH480



MERIDA
W500 D590 H795
SH435



FLORA
W500 D590 H795
SH435



CUBEN FIXED BASE
W650 D650 H800
SH430



CUBEN WITH CASTERS
W600 D600 H800
SH430-525



GENIE
W630 D570 H760
SH450





KURVEN (F) OFFICE CHAIR
W700 D700 H710
SH460



KURVEN (B) OFFICE CHAIR
W700 D700 H710
SH460



KURVEN (B) TRESTLE CHAIR
W605 D610 H770
SH470



KURVEN (F) TRESTLE CHAIR
W605 D610 H770
SH470



KURVEN (F) TRESTLE CHAIR
W605 D610 H770
SH470



CLASSIC WOODEN LEG
W565 D560 H760
SH760



M38 (STACKABLE)
W560 D520 H705
SH435



SKIN TUBE LEG
W600 D530 H810
SH460



SKIN CANTILEVEL LEG
W600 D530 H810
SH460



FAY (H)
W585 D600 H800
SH450



CUBE2
W770 D700 H820
SH430



KOLINI
W585 D610 H840
SH450



M-119
W585 D610 H840
SH450



L19 (1P)
lowback chair
W585 D570 H695
SH450



L19 (1P)
HIGHBACK CHAIR
W585 D610 H840
SH450



S-15
W585 D610 H840
SH450



KOAKOD (B)
W460 D515 H785
SH440



M 385
W445 D515 H800
SH450



M 69
W490 D600 H810
SH450



M 62A
W495 D530 H800
SH450



KOAKOD (F)
W460 D515 H785
SH440



M-119
W470 D550 H820
SH440



M 62
W460 D530 H770
SH400-495



DEAN
W500 D480 H730
SH450



TWELEV
W540 D525 H780
SH450



ALMA (F)
W600 D510 H760
SH475



TWELVE WITH PAD
W540 D525 H780
SH465





M-HOC-CS
W440 D515 H780
SH465

STOOLS

Seating

Stools are available in a range of heights.

To ensure user comfort seating heights need to be paired with the corresponding table height.

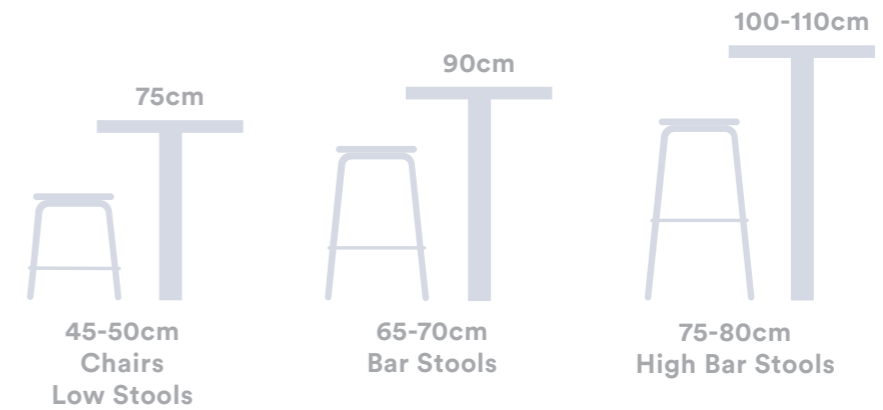

Pebble

Stools

Versatile, contemporary and multi-functional. The Ottomans are a great addition to office breakout and informal areas, and ideal for modern learning environments.



PEBBLE
1 Seats

W750 D730 H430



PEBBLE
2 Seats

W950 D930 H430



PEBBLE
3 Seats

W1150 D1130 H430





**PRIMO (L)
Stool**
W450 D405 H540
SH460



SOL (S)
W405 D405 H450
SH450



HEX
W430 D430 H500
SH500



KITA (S)
W425 D410 H455
SH455



PINN
W510 D510 H430
SH430



KRATIK
W500 D475 H450





PRIMO (M)
W450 D410 H710
SH630



KOAKOD (BM)
W465 D490 H855
SH630



ODIE
W55 D460 H870
SH660



KITA (M)
W440 D410 H625
SH625



FRISKY
W460 D455 H780
SH695



KITA (H)
W465 D410 H765
SH765



WINNIE
W430 D360 H890
SH760



SOL (H)
W350 D350 H720



BARON COUNTER
W480 D440 H990
SH800



PRIMO (H)
COUNTER STOOL
W450 D410 H845
SH770



KOAKOD (BH)
W490 D500 H995
SH760



H-HOC-CS
W450 D495 H1020
SH760



TWELVE (F)
W550 D515 H995
SH775



TWELVE (B)
W550 D515 H995
SH775

MULTI-TASK CHAIRS

Seating

Multi task chairs is a plain of lifestyle

A comprehensive range of multi-purpose chair for perfectly matched to essential usages and interiors with relax and comfort.



restaurant



office



bedroom



study



bar





MOFI

W485 D535 H835
SH 455



MOFI

W410 D430 H630
SH330





PUPE
(Legs - Metal)

W475 D580 H835
SH475



LID

B470 T370 H405
* T is top and B is base



ENRICH

W525 D520 H755
SH475



JOLIE

W510 D520 H790
SH450 MM



PUPE
(Legs - Wooden)

W455 D530 H830
SH450



NOIR

W540 D510 H835 SH760
W540 D510 H735 SH650



PAM

W575 D520 H805
SH460



AGE

W470 D560 H770
SH460 MM





PUFF
(Legs - Wooden)
W540 D530 H817
SH475



PUFF
(Legs - Metal)
W575 D530 H810
SH475



EMPY
W580 D560 H790
SH460



BELLY
W575 D520 H805
SH460



PLUNK
W590 D540 H820
SH470



PLUNK FIXED
W590 D540 H820
SH440



FRAME
W485 D555 H830
SH455 MM



Compactor

Compactor Storage

Compactor is systems, solutions for Industrial Storage Equipment, Material Handling Automation, Rack Protection & Office Storage.

MOBILE SHELVING SYSTEMS

Mobile Shelving Systems offers high-class leading technical innovation, design versatility and user-configurable options.

Double your storage capacity with Compactor Systems with a streamlined singular aisle design cramped? frees up space for othe.



HAND DRIVE

With the basic standard storage solution system, the Hand-Drive unit is the key. It is suitable for limited storage areas and outstanding on long corridors.

Each unit consists of lightweight and strong construction material creating the units to slide effortlessly.

Desegregate handles prevent any obstructions into working spaces and possess uniform appearance.





MECHANICAL DRIVE

Mechanical-Drive units are an upgraded version of Hand-Drive. These units are suitable for a large storage area.

Mechanical units still consist of lightweight and strong construction material, with the use of high tensile aluminum and combination of high-quality woods and plastic.

The special design of these units added the crank handle function which makes moving heavy loads become much easier due to our advanced gear system.

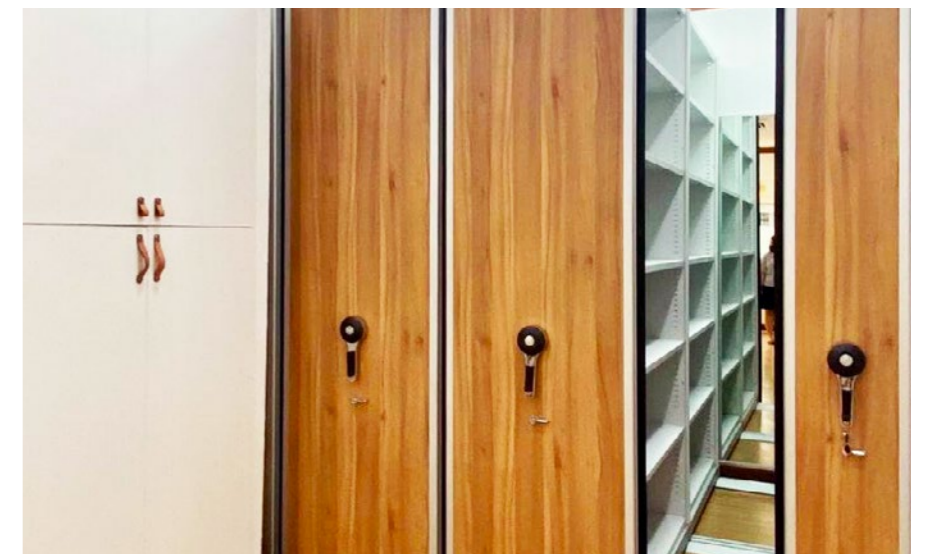

SHELVING SYSTEMS

The shelving system is one of the indispensable pieces of furniture in any building, such as hospitals, offices, schools and every business group.

Compactor Systems, We produce and install shelving that customers can design to fit their space. We are also happy to give advice on the most suitable and creative design.

Our shelving systems are attractive and strong and durable from serving customers for over 20 years.



FLEXI-SHELVE

Flexi-Shelf is a panel shelf system. The shelf consists of an advanced combination of steel and aluminum causing the shelf to withstand and store the products weighing up to 70 kg. With extra reinforcement bars that we can add under the shelves to increase the weight capacity up to 150 kg. The shelves will be able to adjust up and down by 20 mm increments along the shelving system.

Flexi-Shelf also comes with standard optional accessories in the range of Book shelf support, Dividers, Hanging Rack, and etc.



NOVA-SHELVE

Nova Shelving is a lighter version with four-shelving systems. The post frame can both stay open or be fitted with plastics, plain steel panel or polypropylene panel. The shelf has the capacity to store products weighing up to 70 Kg with the ability to level the adjustable to 20 mm increments.

Nova Shelving will provide custom depths for special applications and also comes with standard optional accessories in the range of Cloth Rack, Drawer, Hanging file frame, and etc.

Stack

Steel Storages (Stackable)

To enhance workplace performance, the range of versatile storage system keeps work materials at hand. With STACK steel cabinets, the choices keep coming. Models include mobile pedestal, free standing book shelf cabinet, and lateral filing cabinet. Add it all up, and you have a very complete array of storage system to meet any functional and design requirement. STACK offers attractive combinations of choice and quality at a cost conscious price. Ideal for holding files and documents, STACK can be positioned under the work surface for handy individual storage, or placed outside workstations for archival or shared storage.



Wood Door Handle



U-Type

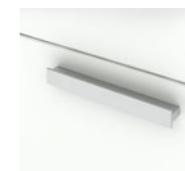

T-Type

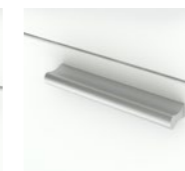

I-Type

Steel Door Handle



Mouse Grey



Yellow



Orange



STORAGES · Storages

STORAGES · Storages



THE OPEN SPACE

The open space office requires elements to separate the operative workspaces. These partitions must serve the needs of the different workstations and at the same time ensure them greater privacy. The modularity of the STACK series and its wide range both of sizes and accessories makes it ideal to respond effectively to these needs. STACK thus serves a dual purpose, as it combines the storage function with that of dividing the spaces and lending decor to the rooms.



locker

The workforce and the office space is dynamics. Users are on the move, in and out of work. The personal storage requirement is increasing. More and more company require personal, and temporary storage for their staff.

The STACK, steel lockers, are available in different widths, height and finishes. It make STACK locker highly adaptable to all spaces and uses.



MELAMINE

FARIC

EDGE BANDING

HANDLE

METAL

LEATHER / VINYL

ACRYLIC

GLASS

POLYCARBONATE

“

MATERIALS

&

FINISHES

”

MELAMINE

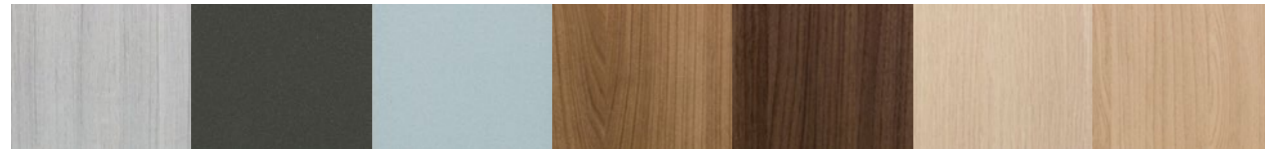

Avignon MV Charcoal ME Glacier MS Cherry capucino MU Noce nogaro MN OAK-69A MO Shimo ash MH

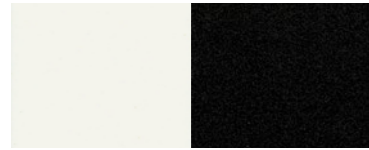

Ice white MW Storm black MK

FABRIC

G1 Newlight : Chairs / Panel

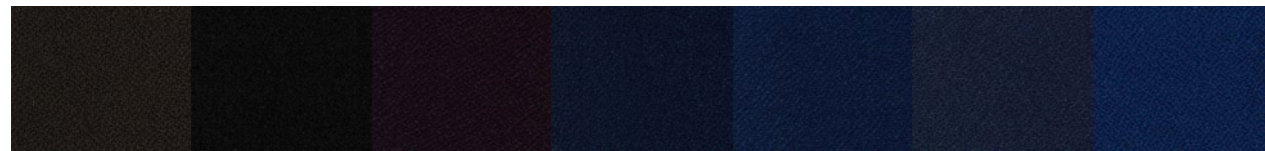

Chocolate 78-BR Black gold 89-BA Raisin 68-PU Royal blue 512-BL Deep blue 511-BL Ocean 58-BL Navy 510-BL



China blue 64-PU Expensive blue 55-BL Sapphire 54-BL Wedge wood 52-BL Fluorescent blue 53-BL Sky 51-BL Stream line 62-PU

G1 Newlight : Chairs / Panel

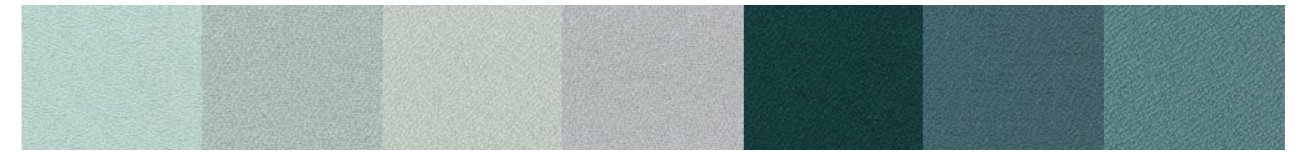

Spring 57-BL Silver 91-GY Bluegrass 44-GR Cool grey 90-GY Avocado 412-GR Mineral 47-GR Green olive 46-GR

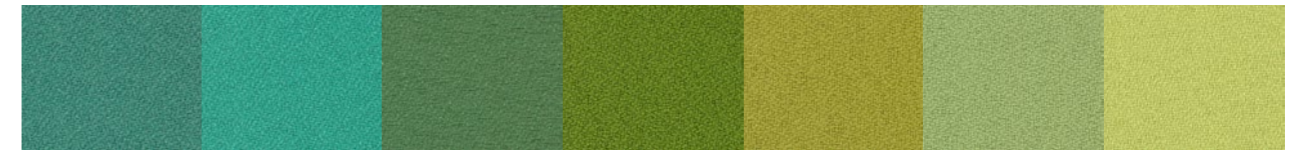

Atlantis 56-BL Emery 59-BL Forest 45-GR Jade 43-GR Sapgreen 49-GR Ultra 48-GR Cream gold 42-GR

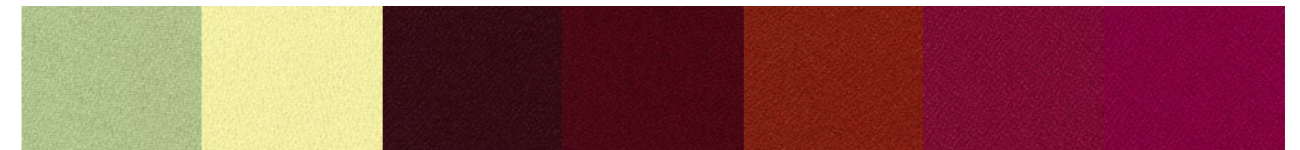

Fresh green 41-GR Lemon 31-YE Bordeaux 152-BR Ruby 18-RE Brick red 19-RE Plum 14-RE Persian red 16-RE



Raja 15-RE Fortune red 17-RE Mars red 20-OR Desert sun 22-OR Sunflower 38-YE Sun king 27-OR Brilliant yellow 35-YE

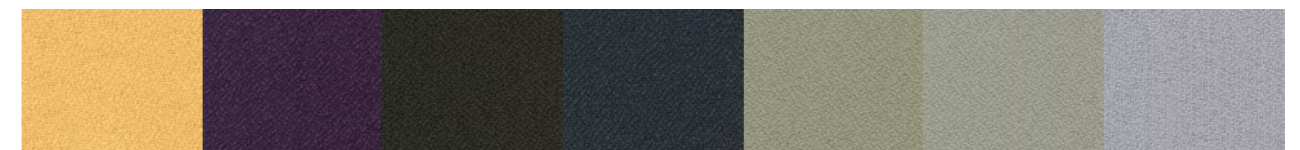

Damson 156-PU Night gold 97-GY Black pearl 98-GY Grey 93-GY Pewter 94-GY Bisque 73-BR Seasprey 50-BL



Seashell 71-BR Wheat 75-BR Cream 72-BR Pearl 01-WH Barley 02-WH Sunrise 34-YE Sand 74-BR

G1 **Platinum** : Panel

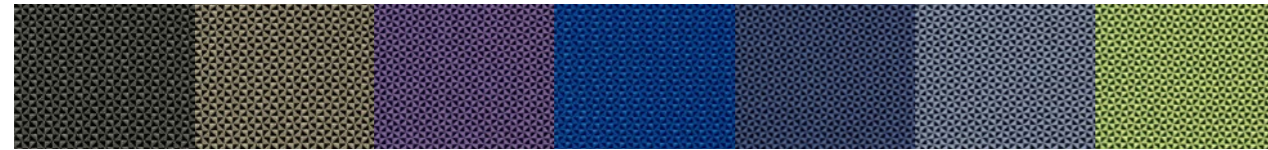

Granite P04 Khaki P03 Dark orchid P07 Skyway P17 Midnight blue P11 Laguna P16 Spring green P09

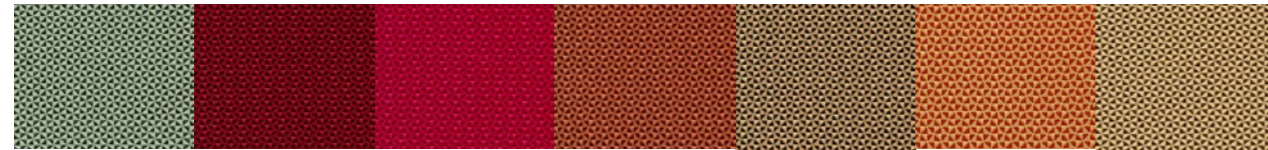

Olive P10 Deep Crimson P06 Hibiscus P15 Umber P14 Honeycomb P18 Golden orange P05 Wheat P13

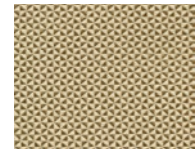

Chalk P12

G1 **Season** : Panel



Amber SE05 Black SE15 Grey SE03 Sapphire SE13 Deep sea SE07 Aqua SE10 Sky SE12

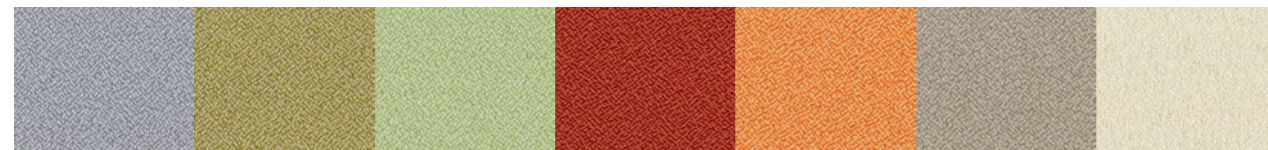

Silver SE02 Meadow SE09 Leaf SE08 Flame SE11 Peach SE06 Pearl SE01 Ivory SE04

G1 **Golden land** : Panel

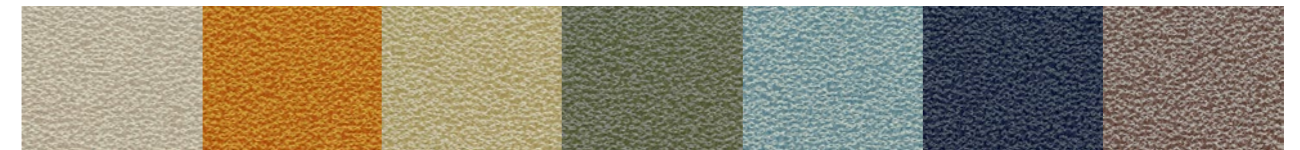

Sand 01-WH Pagoda 22-OR Golden carpet 32-YE Lake 42-GR Summer 51-BL Sea 58-BL Castle 72-BR

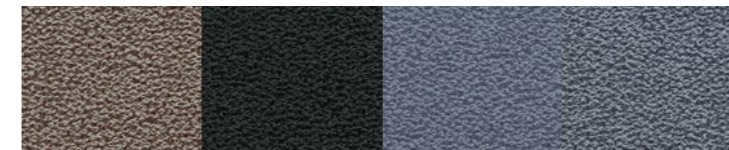

Tropical 78-BR Valley 88-BA Paradise 93-GY Lagoon 96-GY

G2 **Roma** : Panel

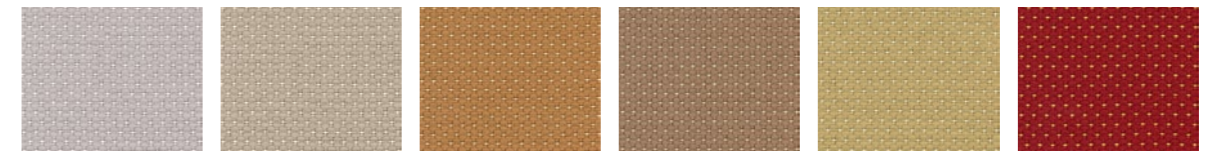

Silver R-11 Sand R-12 Golden R-13 Oxford R-14 Lime R-15 Terra R-16

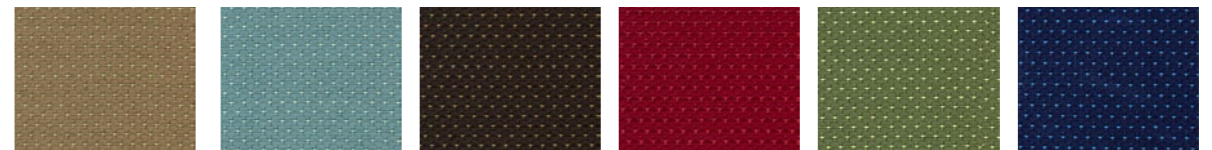

Ash R-17 Breeze R-18 Cocoa R-19 Maroon R-20 Leaf R-21 Night pound R-22



Midnight R-23 Fire work R-24 Lake R-25

G2 **Zuri** : Sofa / Loose Furniture / Panel

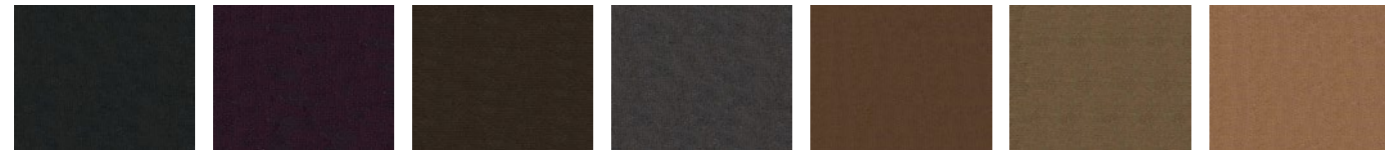

ZUR177 16 ZUR177 14 ZUR177 07 ZUR177 15 ZUR177 06 ZUR177 04 ZUR177 05



ZUR177 03 ZUR177 02 ZUR177 10 ZUR177 12 ZUR177 13 ZUR177 11 ZUR177 09

G2 **Calic** : Sofa / Loose Furniture / Panel



CAC842 08 CAC842 07 CAC842 06 CAC842 05 CAC842 02 CAC842 01 CAC842 03

G2 **Bistro** : Sofa



BIS479 05 BIS479 04 BIS479 03 BIS479 02

G2 **Flossy** : Sofa / Loose Furniture / Panel

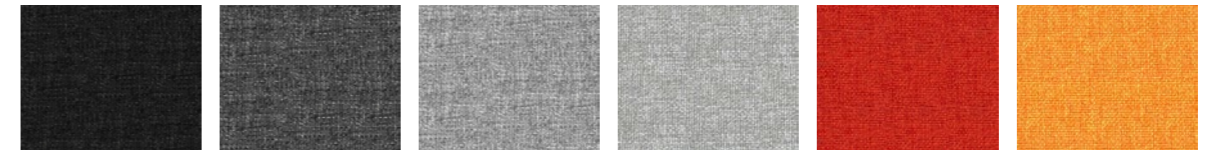

FLO843 07 FLO843 08 FLO843 09 FLO843 02 FLO843 04 FLO843 03



FLO843 06 FLO843 10 FLO843 11 FLO843 12

G2 New **Alexa** : Sofa

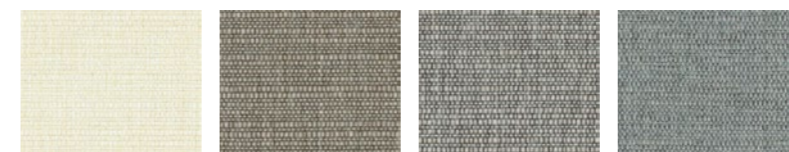

ALE665 01 ALE665 02 ALE665 03 ALE665 04



ALE665 08 ALE665 07 ALE665 06 ALE665 05

G2 New Allergen Proof1 : Sofa

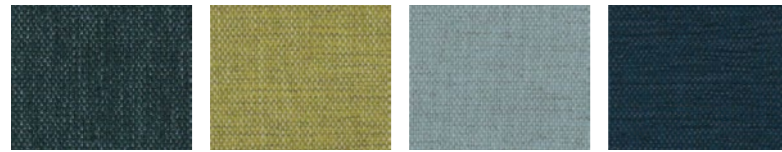

ALG861 04 ALG861 05 ALG861 06 ALG861 07

G2 New Allergen Proof2 : Sofa

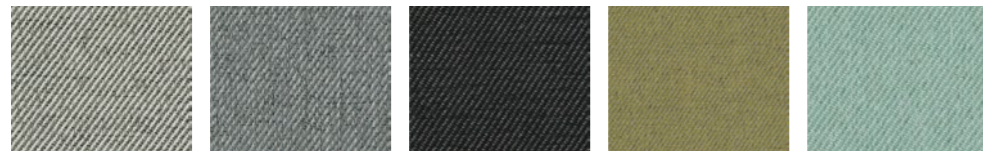

ALG862 02 ALG862 03 ALG862 04 ALG862 05 ALG862 06

G2 New Allergen Proof3 : Sofa

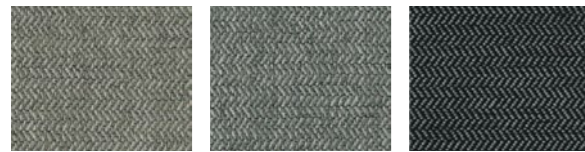

ALG863 01 ALG863 02 ALG863 03

G2 New Clinique Plus : Sofa



CNP352 01 CNP352 02 CNP352 03 CNP352 03

G2 New Cottolique : Sofa



CLQ732 02 CLQ732 04 CLQ732 05

G2 New Dimo1 : Sofa Only

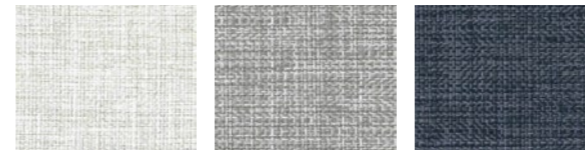

DMO746 01 DMO746 02 DMO746 03

G2 New Dimo2 : Sofa

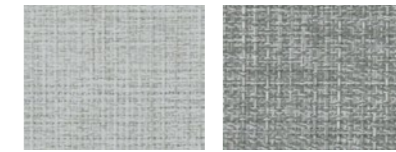

DMO747 01 DMO747 02

G2 New Fermo : Sofa Only

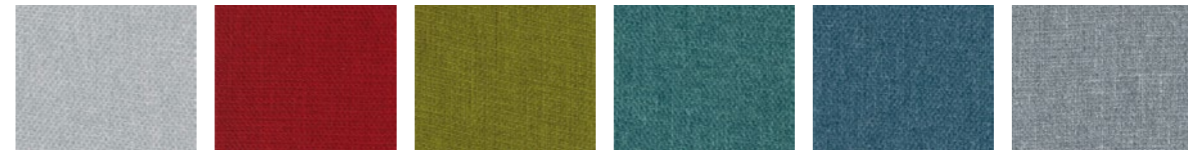

FER830 02 FER830 05 FER830 06 FER830 07 FER830 08 FER830 11

G2 New Happ2 : Sofa



HPP947 01 HPP947 02 HPP947 03 HPP947 04 HPP947 05 HPP947 06

G2 New Keen : Sofa

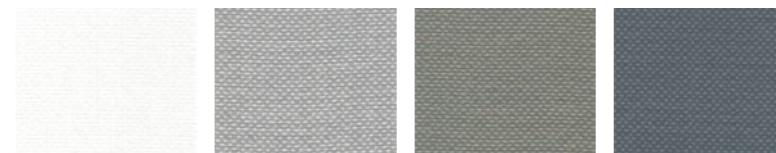

KEE269 01 KEE269 02 KEE269 03 KEE269 04

G2 New **Lauren** : Sofa



G2 New **Luster** : Sofa



G2 New **Marni** : Sofa



G2 New **Maxwell** : Sofa

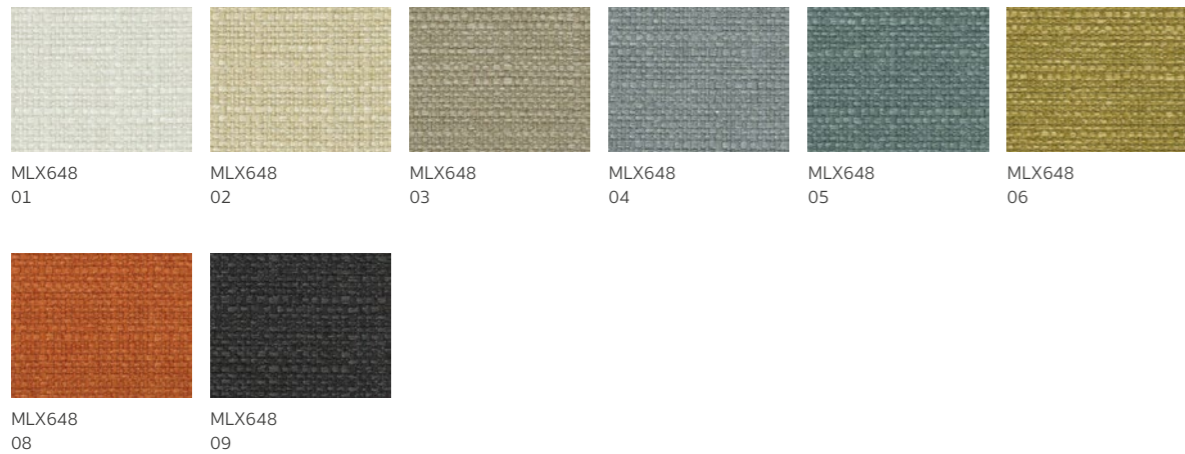

G2 New **Modish1** : Sofa



G2 New **Sacco** : Sofa



G2 New **Splendid** : Sofa



G2 New **Umi** : Sofa

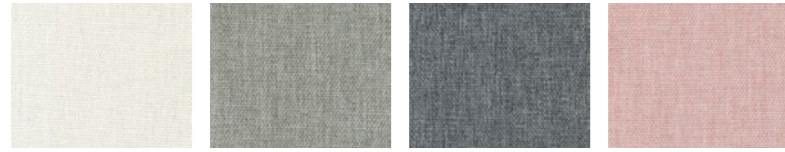

UMI157 01 UMI157 02 UMI157 03 UMI157 04

G2 New **Vivi** : Sofa



VIV146 01 VIV146 02 VIV146 03 VIV146 04 VIV146 05 VIV146 06

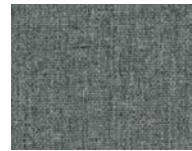

VIV146 07

G3 **Zebra** : Sofa Myraid Only



Ruby 05 Sapphire 08 Citrin 09 Emerald 10

Sak : Classic Chair Only



CN9701 CN9702 CN9703

Bamboo : Classic Chair Only

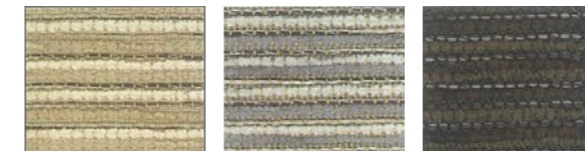

CN8701 CN8702 CN8703

EDGE-BANDING



Noce nagaro Cherry capucino Oak 69A Shimo ash

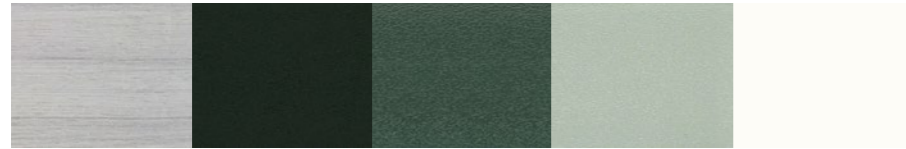

Avinion Storm black Charcoal Gracier Ice white

HANDLE

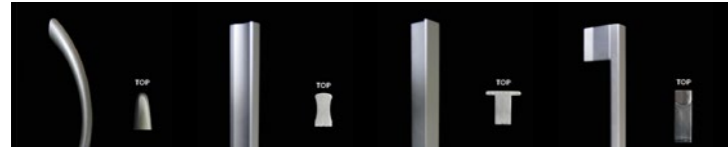

C-Type I-Type T-Type U-Type

METAL

Powder Coated Steel



Arabica black FB Charcoal FE Mouse grey FD Pearl silver FS Alpine white FW



Fire orange FO Moss green FG Ocean blue FU Rose Pink FP

LEATHER : Executive Chair / Sofa

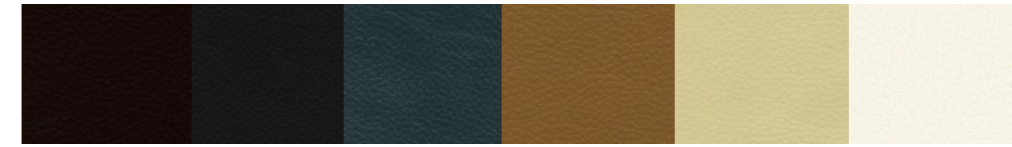

Mocha Black Dark grey Whisky Ivory White

P1 VINYL : Executive Chair / Sofa

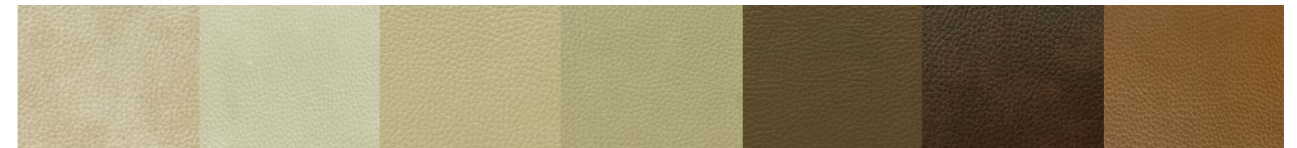

Sand JU 01 Ivory JU 16 Tan JU 18 Khaki JU 19 Taupe JU 20 Brunette JU 03 Walnut JU 24

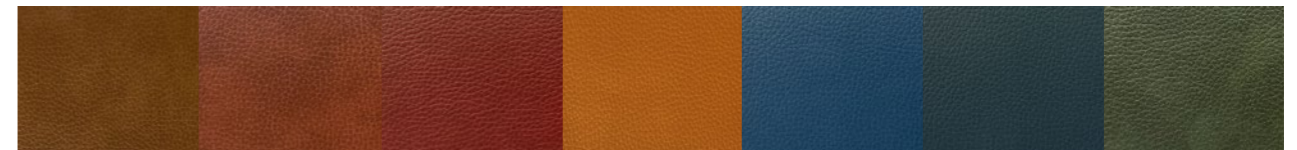

Cinnamon JU 04 Burgundy Brown JU 02 Merlot JU 11 Tangerine JU 21 Royal Blue JU 22 Navy Blue JU 23 Wood JU 05

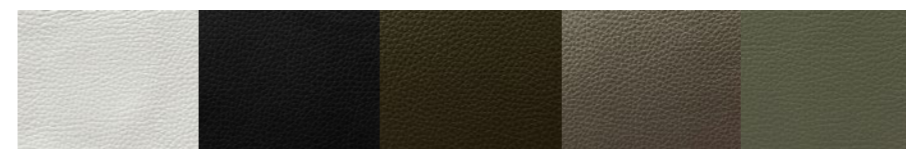

White JU 15 Black JU 13 Dark Chocolate JU 26 Cafe JU 12 Smoke JU 25

ACRYLIC



Clear Frosted white

GLASS



Black GB White GW

POLYCARBONATE



Tea Marine Clear

ECOLOGY & THE ENVIRONMENT

We have a green soul

we understand the difference of steps toward the sustainable organization, and realize that we can only achieve this by working together with everyone in our company. in order to achieve our goals we have implemented an environmental management system based on the iso standard, which allows for a comprehensive approach to ecology.



ANSI/BIFMA

The Business and Institution
Furniture Manufacturer's Association.



SCS INDOOR AIR QUALITY

Certify to the most transparent Indoor Air Quality (IAQ) standard for furniture and building materials .



ISO 45001: 2018
Specifies requirement for an occupational health and safety management system



ISO 9001: 2015
Specific requirements for a quality management system



ISO 14001: 2015
Gives the requirements for environmental management systems



ISO 50001: 2011
Energy management system

Unlock your potential, access your best work



Our purpose is more important than ever as we work together to create a better world of work.

At Rockworth, creating a satisfyingly efficient workplace in which people can cultivate their potential is at the heart of what we do. Because we know that an inspiring workspace is important both for employee well-being and organization performance. Our focus is sustainable products that help people to work better and learn better.

Rockworth is about people, driven by purpose. We believe that an inspiring workspace increase the joy of work, comfort, wellbeing and productivity.

We design and create furniture for the modern workspace, with the needs of employee in mind. We offer a variety of modern, durable and functional solutions. Our products are designed to serve the needs of people at work that supports a better ways of working, collaboration and socializing. Every working day.

Rockworth

Rockworth Public Company Limited
294-300 Asoke-Dindaeng Rd, Bangkapi,
Huai Khwang, Bangkok 10320

 +66 (2) 123-8888

 sales@rockworth.com

 [rockworth.official](https://www.facebook.com/rockworth.official)

 [rockworth.official](https://www.instagram.com/rockworth.official)

 [rockworth](https://www.youtube.com/rockworth)

 [rockworth.official](https://line.me/tv/rockworth.official)

We design and create furniture for the modern workspace, with the needs of employee in mind. We offer a variety of modern, durable and functional solutions. Our products are designed to serve the needs of people at work that supports a better ways of working, collaboration and socializing. Every working day.