

**Rockworth**<sup>®</sup>  
Working progress

# Rubix S.72

Collaboration . Flexibility .  
Budget Integration .

[rockworth.com](http://rockworth.com)



# THE PERFECT WHICH CAN BE DESIGNED

---

By Design, to enhance the staff capacity with maximum efficiency, "RUBIX series" is designed for Collaboration, Flexibility and Simple Modern Look. Rubix helps the user adjust the placement and configuration as per their need with options for supporting individual behavior. "RUBIX" system is the best answer for all lifestyle, reflecting what you are.



RUBIX DESIGN  
**OFFICE FURNITURE**





# RUBIX DESIGN COLLABORATION

## TEAMWORK REVEALING THE HIDDEN POTENTIAL

While combining the unique identity of each individual, discussion and sharing performance with each other is encouraged. "Rubix" system contributes to TEAMWORK conditions in order to reach accomplishment at work, while supporting distinction on the way you are.





Communication is a necessity for the accomplishment of work in an office. Rubix is designed with Flexibility to deal with the day to day challenges, effectively.



# RUBIX DESIGN FLEXIBILITY

PRODUCTIVITY  
PRIVACY  
COMFORT  
CREATION

Flexibility in workspace increases in employee's comfort, well-being, and productivity. Rubix is designed to meet the requirements of the Executive as well. Luxury Design, Luxury Lifestyle





# RUBIX DESIGN BUDGET INTEGRATION

TEAMWORK  
IS A  
KEY TO  
SUCCESS

Rubix series is designed with various materials to suit the function and pocket and is made suitable for your lifestyle with maximum efficiency.



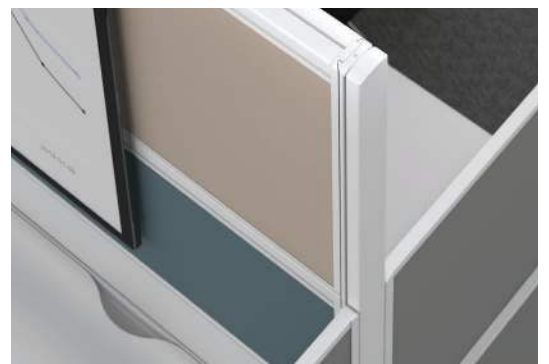

RUBIX series have been designed to reduce cost with various forms of Hybrid-Pole design which fulfilling all needs perfectly with high quality.





# VARIOUS DESIGN OPTIONS

## LEG DESIGN FUNCTION

RUBIX has not only been fabricated by high-grade materials but we have also re-designed RUBIX legs with various materials and styles to support all usage formats. Users will be able to transform RUBIX's leg styles as needs.



Single leg  
**TYPE A**



Single leg  
**TYPE B**



Single leg  
**TYPE C**

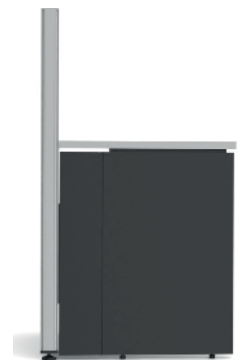

Single leg  
**TYPE D**

# THE ANSWER FOR ALL DETAILS OF NEEDS

Rockworth has defined the perfect design, in Rubix, with functionality and flexibility to meet the needs of the user. With perfect design as the main focus, we are equipped to create a modern workstation, with RUBIX, which can deal with any challenges that might occur at the workplace.



## RUBIX PANEL FUNCTION

RUBIX panel has been designed to support all usage formats. Users can select RUBIX panel as needs to facilitate their work effectiveness or to match with their office's conditions.

## LEG

There are various RUBIX leg designs to support various work space. RUBIX leg has been fabricated by high quality steel with 75-micron anti rust power coating.

## ACCESSORY FUNCTION

Our accessories has been designed to make users more comfortable. Users can select various accessories as needs to facilitate your work effectiveness.



## ABOVE POWER ACCESS

Above Power Access makes the user reaches the important data source, and shares their own data together easily. Above Power Access has been designed to support new technology for increasing work effectiveness. Above Power Access could be your appropriate answer for your work space.



### **HYBRID POLE**

HYBRID pole has been designed to support both thick and thin panels of workstation. Users can transform their workstation easily with HYBRID pole because it has been designed for simple installation. Smart-look workstation will be established in short time.



### **OVERHEAD CABINET**

Overhead Cabinet will make you have more work space, and it will be a safety storage for your confidential files.



### **SLIM PANEL**

Slim Panel has been designed to reduce your installation cost, and its light weight will make users clean it easily. The Slim Panel will bring the most appropriate atmosphere to your workstation.



### **BELOW POWER ACCESS**

Below Power Access makes the user reaches the important data source, and enhances performance with more work-space. Below Power Access has been also designed to support various working styles with all new technologies.

# SIGNIFICANCE OF HEIGHT

## PANEL

### AVAILABLE HEIGHT & WIDTH

• HEIGHT : 1190 | 1640

• WIDTH : 600 | 750 | 900 | 1200 | 1500



#### **1** STANDING EYE-LEVEL

Partial Standing Privacy has been designed to decrease any disturbance around your work space in high level but the users can keep collaborating with each others while standing.

#### **2** SITTING PRIVACY

Eye Level Seated Privacy also creates the privacy atmosphere while working in workstation, and the user can keep communicating with each others even while sitting.

## SLIM PANEL

### AVAILABLE HEIGHT & WIDTH

• HEIGHT : 1190 | 1640

• WIDTH : 600 | 750 | 900 | 1200 | 1500

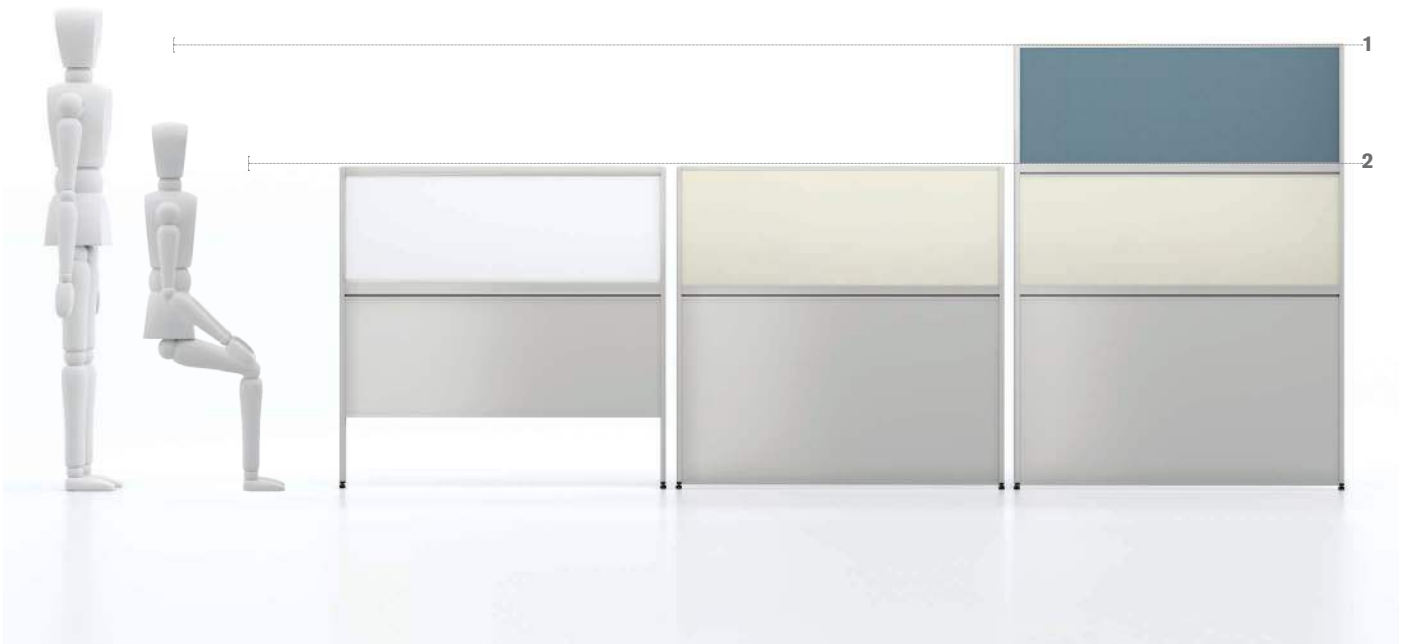

#### **1 STANDING EYE-LEVEL**

Partial Standing Privacy has been designed to decrease any disturbance around your work space in high level but the users can keep collaborating with each others while standing.

#### **2 SITTING PRIVACY**

Eye Level Seated Privacy also creates the privacy atmosphere while working in workstation, and the user can keep communicating with each others even while sitting.

# EASY FOR ESSEMBLY

As our main design concept, we would like the user reaches our comfortable products which can be the answers for all office types. The panels have been designed to be movable and easy to assemble which would be able to meet the user's needs.

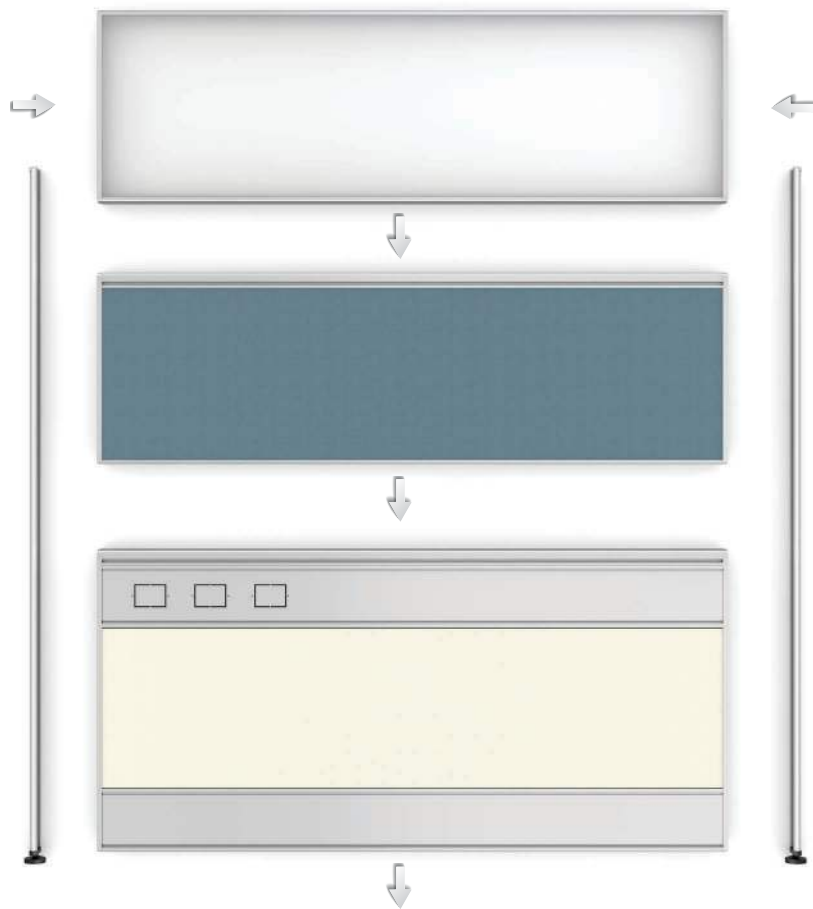

**STEP 1**  
POLE



**STEP 2**  
BELOW

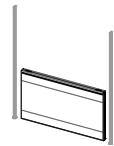

**STEP 3**  
ABOVE

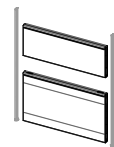

**STEP 4**  
ABOVE

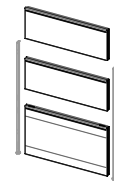

1



2



## POLE DETAILS

### 1 POLE - END

It has been made from injected-plastic which is more durable and makes more smooth connection.

### 2 ADJUSTER

It has been also made from injected-plastic which supports horizontal assembly. Even though you haven't had smooth floor surface, the adjuster can be stretched with additional 10 millimeter height.

### 3 ASSEMBLY FORMATS

With more comfortable assembly concept, the lower support track has been designed as a slide-track which makes the user setup the panel set easily both assembly and disassembly as user'd needs.

3

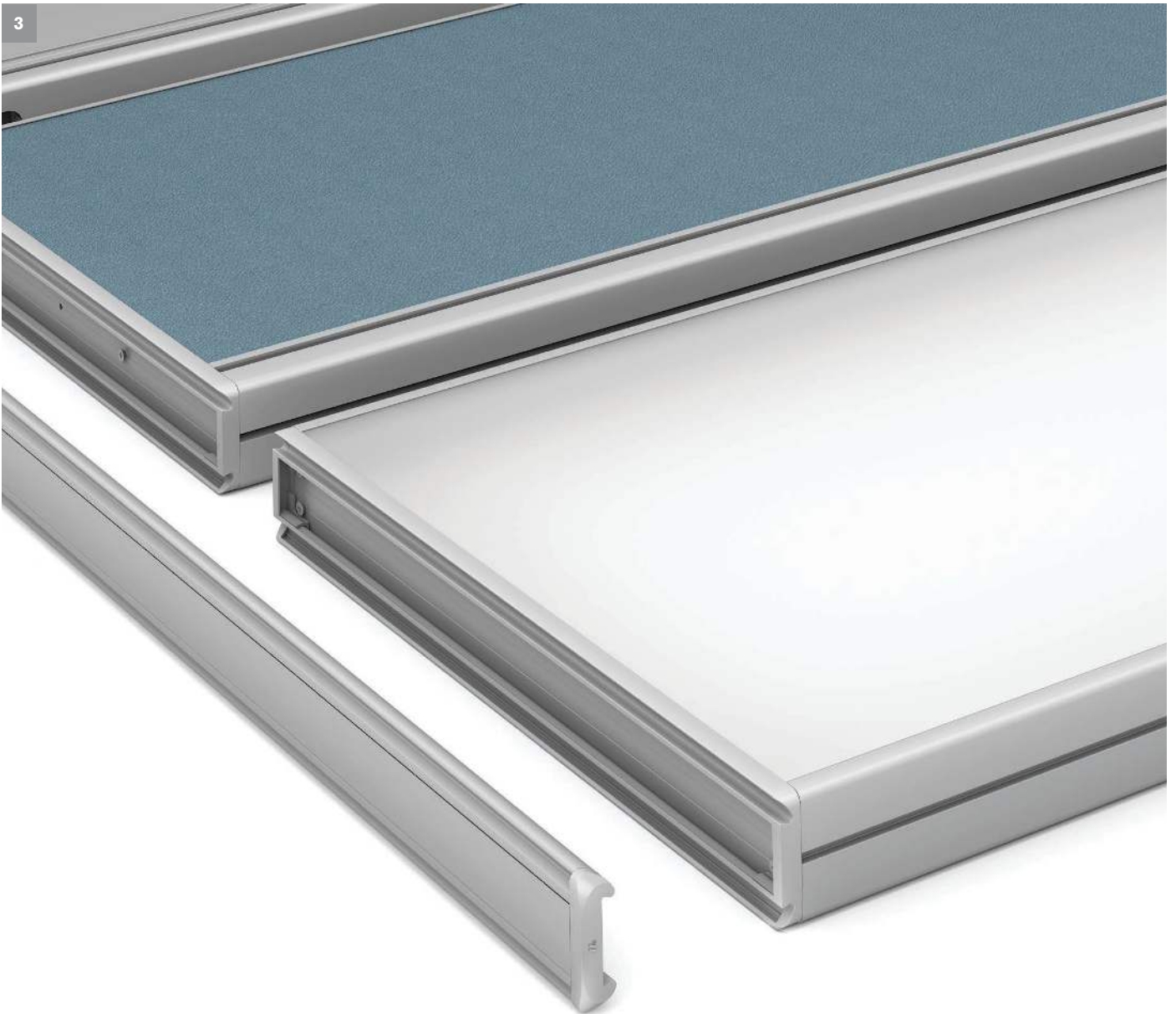

# GET CONNECTED GET MORE POTENTIAL

As the current appliance formats, we have created more flexible workstation which meets the basic needs of all users especially wiring support. It has been designed to be adjusted easily. That means the user can also change the workstation layout easily. Moreover, it can support new technology which would facilitate the user's work potential as well.

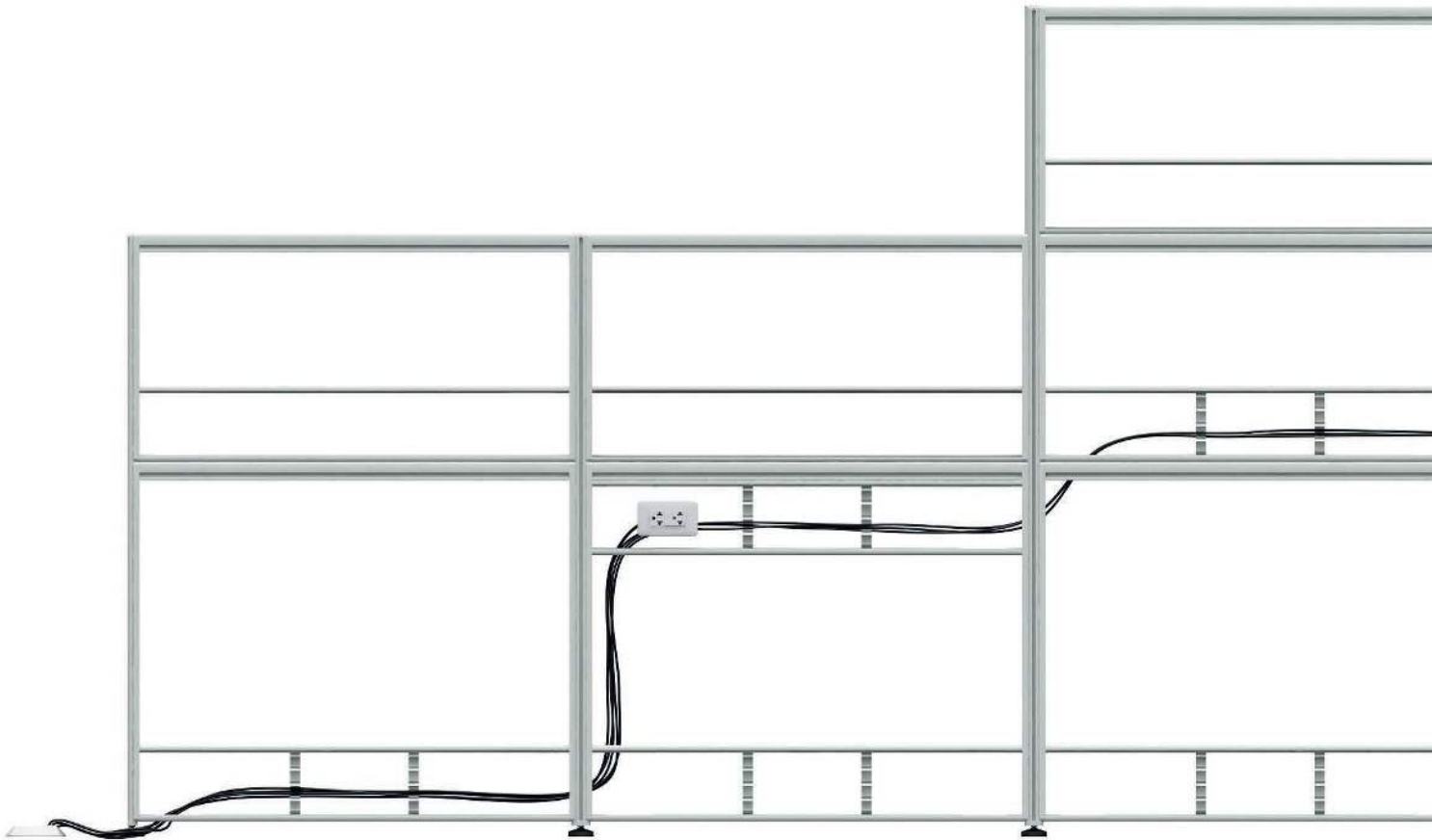

## RACE - WAY

Electric cables can be wired from the below Race-Way to the upper Power Access. It has been designed to support continual wiring from panel to panel which can be selected as user's needs.



## BELOW POWER ACCESS

Wiring junctions can be selected as necessary to support the different usages such as wiring to Power Access, or wiring from panel to panel for internal wiring as well.



## RACE - WAY

Race-Way structure has been designed to support systematic wiring. Electric cables can be arranged by separating channel of each panel orderly.

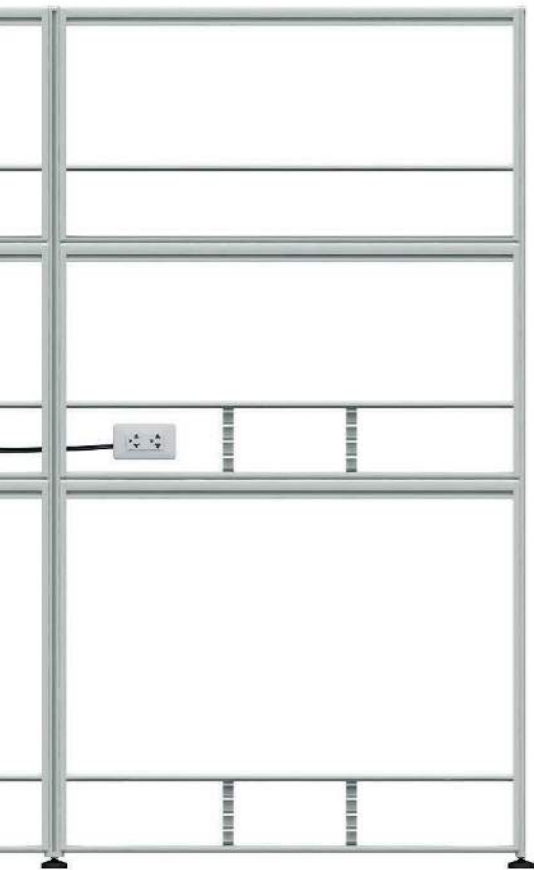

## SAMPLE WIRING FOR DIFFERENT WORKSTATIONS

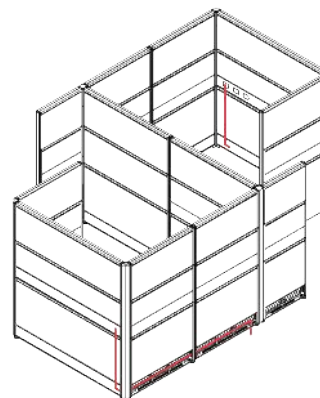
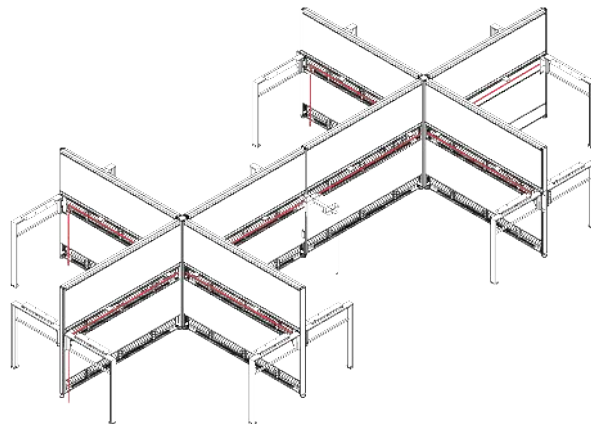
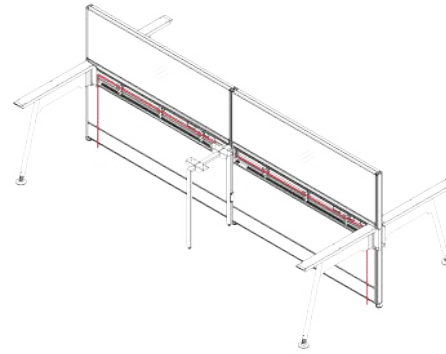

### ABOVE POWER ACCESS

Internal Power Access Points connecting with Face-Plates, standard plug, can be support any electrical equipment as the user's needs.

# THE DIFFERENTS YOU CAN CHOOSE



BELOW IS FABRIC PANEL, ABOVE IS FABRIC WITH GLASS PANEL



BELOW IS FABRIC PANEL, ABOVE IS GLASS PANEL



BELOW IS FABRIC PANEL, ABOVE IS MAGNETIC PANEL AND ABOVE WORKSURFACE POWER ACCESS



BELOW IS FABRIC PANEL, ABOVE IS MAGNETIC PANEL AND BELOW WORKSURFACE POWER ACCESS



BELOW IS FABRIC PANEL, ABOVE IS FABRIC WITH GLASS PANEL AND BELOW WORKSURFACE POWER ACCESS

## PANEL CAN BE ADJUSTED AS INDIVIDUAL USAGE

The panel with 1190mm. height can be adjusted as individual usage. The panel material and the position of power access can be also adjusted as needs.



BELOW IS FABRIC PANEL, ABOVE IS GLASS PANEL AND LOWER RACE-WAY



BELOW IS FABRIC PANEL, ABOVE IS FABRIC WITH MAGNETIC PANEL AND LOWER RACE-WAY



BELOW IS FABRIC PANEL, ABOVE IS MAGNETIC PANEL AND ABOVE WORKSURFACE POWER ACCESS AND LOWER RACE-WAY



BELOW IS FABRIC PANEL, ABOVE IS GLASS PANEL AND BELOW WORKSURFACE POWER ACCESS AND LOWER RACE-WAY



BELOW IS FABRIC PANEL, ABOVE IS FABRIC WITH GLASS PANEL AND BELOW WORKSURFACE POWER ACCESS AND LOWER RACE-WAY

## CONTRIBUTE THE BETTER ATMOSPHERE AT WORK PLACE

With different design, slim panel has been designed to assemble with the 25mm. thickness panel in order to contribute the better atmosphere at work place but the user still can choose panel assembly formats as well.



BELOW IS FABRIC PANEL, ABOVE IS MAGNETIC PANEL (SLIM PANEL LOWER OPEN)



BELOW IS FABRIC PANEL, ABOVE IS GLASS PANEL



BELOW IS FABRIC PANEL, ABOVE IS TWO MAGNETIC PANEL



BELOW IS FABRIC PANEL, ABOVE IS TWO MAGNETIC PANEL



BELOW IS FABRIC PANEL, ABOVE IS FABRIC WITH TWO MAGNETIC PANEL



BELOW IS FABRIC PANEL, ABOVE IS MAGNETIC WITH GLASS PANEL AND ABOVE WORKSURFACE POWER ACCESS



BELOW IS FABRIC PANEL, ABOVE IS MAGNETIC WITH GLASS PANEL AND BELOW WORKSURFACE POWER ACCESS



BELOW IS FABRIC PANEL, ABOVE IS FABRIC WITH TWO MAGNETIC PANEL AND BELOW WORKSURFACE POWER ACCESS AND LOWER RACE-WAY

### THE APPROPRIATE ANSWER FOR PRIVACY FEELING

The panel with 1640mm. height is the appropriate answer for privacy feeling. The panel can be adjusted as individual usage. The panel material and the position of power access can be also adjusted as needs.



BELOW IS FABRIC PANEL, ABOVE IS TWO MAGNETIC PANEL AND LOWER RACE-WAY



BELOW IS FABRIC PANEL, ABOVE IS FABRIC WITH MAGNETIC WITH GLASS PANEL AND LOWER RACE-WAY



BELOW IS FABRIC PANEL, ABOVE IS MAGNETIC WITH GLASS PANEL AND ABOVE WORKSURFACE POWER ACCESS AND LOWER RACE-WAY



BELOW IS FABRIC PANEL, ABOVE IS TWO MAGNETIC PANEL AND BELOW WORKSURFACE POWER ACCESS AND LOWER RACE-WAY



BELOW IS FABRIC PANEL, ABOVE IS FABRIC WITH TWO MAGNETIC PANEL AND BELOW WORKSURFACE POWER ACCESS AND LOWER RACE-WAY

### DESIGNED FOR MORE COMFORT WORKING STYLE

This panel style has been designed for more comfort working style with high efficiency with various materials and functions such as the magnet board panel which can be both panel and data collection board at the same time.



BELOW IS FABRIC PANEL, ABOVE IS HYBRID MAGNETIC WITH GLASS PANEL



BELOW IS FABRIC PANEL, ABOVE IS HYBRID WITH MARKET BOARD PANEL



BELOW IS FABRIC PANEL, ABOVE IS FABRIC WITH TWO MAGNETIC PANEL AND BELOW WORKSURFACE POWER ACCESS AND LOWER RACE-WAY

# MORE CONVENIENT WITH ADDITIONAL DETAILS

## WORKSURFACE

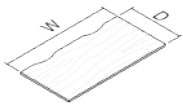

RECTANGULAR  
WORKSURFACES  
TYPE A

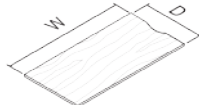

RECTANGULAR  
WORKSURFACES  
TYPE C

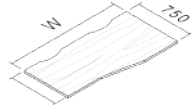

TRANSITION CURVILINEAR  
WORKSURFACES  
600/750

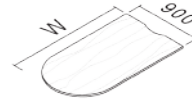

D-SHAPED  
CONVERGENT

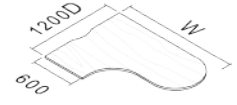

D-SHAPED CONVERGENT  
WRAP - AROUND  
600

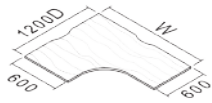

CORNER 90  
WRAP - AROUND  
EXTENDED  
600/600/1200D

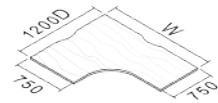

CORNER 90  
WRAP - AROUND  
EXTENDED  
750/750/1200D

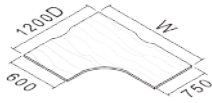

CORNER 90  
WRAP - AROUND  
EXTENDED  
600/750/1200D

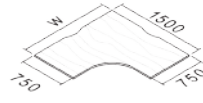

CORNER 90  
WRAP - AROUND  
EXTENDED  
600/600/1200D  
750/750/1200D

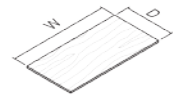

RECTANGULAR  
RETURN

## WORKSURFACE EXTENSION



TEAR DROP

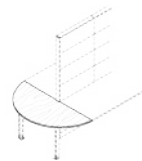

SEMI - CIRCULAR  
END TOP

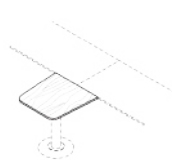

KEY END SING  
TOP

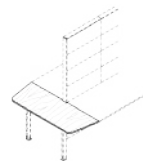

KEY END DOUBLE  
TOP



TEAR CURVE  
DROP

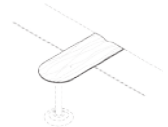

BETWEEN  
COUNTER

## LEG



SINGLE LEG  
TYPE A



SINGLE LEG  
TYPE B



SINGLE LEG  
TYPE C



SINGLE LEG  
TYPE D

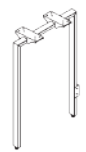

SINGLE  
SHARE STEEL  
LEG

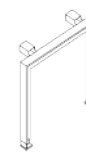

DOUBLE  
SUPPORT LEG

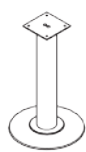

CIRCLE  
SUPPORT LEG

POST / HYBRID POST



END POST



ONE WAY POST



TWO WAY 90 POST



THREE WAY 90 POST



FOUR WAY 90 POST



**HYBRID**  
END POST /  
ONE WAY POST



**HYBRID**  
TWO / THREE WAY  
90 POST



**HYBRID**  
FOUR WAY  
90 POST

CONNECTION STYLE



TWO WAY  
90 POST



THREE WAY  
90 POST



FOUR WAY  
90 POST



ONE WAY  
POST



END  
POST



**HYBRID**  
TWO WAY  
90 POST



**HYBRID**  
THREE WAY  
90 POST



**HYBRID**  
FOUR WAY  
90 POST



**HYBRID**  
ONE WAY  
POST



**HYBRID**  
END  
POST



# Step toward the green

We will design our products,  
processing and building for  
the environment.



It has been over a few years that **ROCKWORTH** has studied the consequences to the environment caused by our business. The study is conducted not only within our organization but also to our customers, suppliers and other environmental specialists.

**WE UNDERSTAND** the difference of steps toward the sustainable organization and realize that we can only achieve this by working together with everyone in our company. Starting from product design, production through delivery and installation.

**IN THE JOURNEY OF** sustainable business and environmental friendly, we continuously focus on the following development and improvement.

- Our products meet or exceed applicable legal requirements and other requirement related to the environment aspects of the organization.
- We are continuously improving performance focus on preventing pollution, reducing waste and reducing consumption of non-renewable energy.
- We are implementing technologies to efficiently use of energy resources.
- We design, process and produce our products for the environment.
- We promote environmental knowledge and awareness.

# Rockworth<sup>®</sup>

Working progress

© 2017 Rockworth Public  
Company Limited.

[rockworth.com](http://rockworth.com)

Get in touch to learn more about  
our product range or how we can  
help improve your client's working  
environment.



Thailand Headquarters  
Rockworth Public Company  
Limited  
294-300 Asoke-Dindaeng Rd.  
Huaykwang, Bangkok 10320  
Thailand

SAARC Regional Office: India  
Rockworth Systems Furniture  
India Pvt. Ltd.  
No. 800 West, R1-South, Sri City  
SEZ-Processing Area, Irugulam  
Post, Satyavedu Mandal, Chittoor  
District-517588, Andhra Pradesh  
India

MEA Regional Office: Dubai  
Rockworth Systems Furniture  
Middle East FZE  
P.O. Box: 14662 Dubai,  
United Arab Emirates

T. +66 2 246 8888  
F. +66 2 247 8899  
E. [sales@rockworth.com](mailto:sales@rockworth.com)

T. +9180 4098 5438  
E. [sales@rockworthinternational.com](mailto:sales@rockworthinternational.com)

T. +9715 0457 8032  
E. [sales@rockworthinternational.com](mailto:sales@rockworthinternational.com)